



Create A Table



*have fun and
create a table that is yours*

1. Choose a Table Top

Choose from a variety of shaped table tops. Some tops are crafted from 2" thick solid Alder butcherblock, others are a refined 1 1/4" solid Alder plank.

In this offering, you will find tables that comfortably seat six, eight or even twelve. Look for the seating capacity symbol on the following pages. Minimal assembly is required.

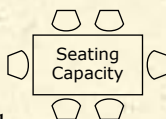

Plank



Butcherblock

2. Choose a Leg

Combine a table top with stylish standard legs, large legs or counter height legs. Standard and large legs are offered in country or transitional styles. Our gathering legs allow you to put your table at island height for use with counter stools. To calculate approximate table height, add the gathering leg height to the thickness of the table top. Made of solid American Alder hardwood. All leg kits sold separately.

Standard Legs



Double Pedestal Options

See page 22.



Cap & Button Kit • 190W

Required to complete the double pedestal look, the Cap & Button Kit contains four wood buttons, four apron caps and hardware.

Large Legs

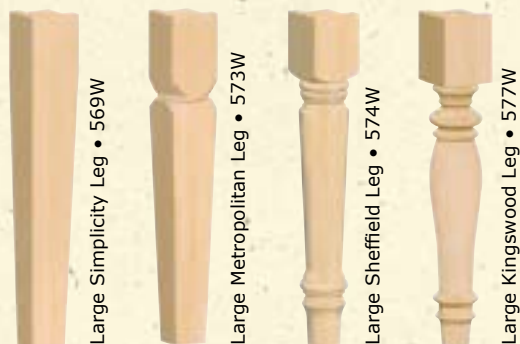

Standard Counter Height Legs





Large & Standard Collection

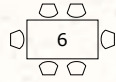
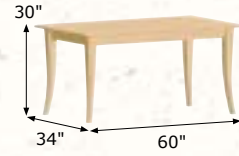

Shown with Saber Legs • 580W

Rectangular Plank Top • 530W

This top is made from 1 1/4" solid Alder planking and features a classic beveled edge. It will comfortably seat six. This top can be combined with any of the styles of legs featured. Our gathering legs allow you to put your table at island height for use with counterstools. Made of solid Alder hardwood.



Bordeaux Legs • 555W



Heritage Legs • 557W



Large Sheffield Legs • 574W



Metropolitan Legs • 559W



Large Metropolitan Legs • 573W



Simplicity Legs • 562W



Large Simplicity Legs • 569W



Large Kingswood Legs • 577W



530W Plank Table Top with 580W Saber Leg and 467W2 Avignon Chairs

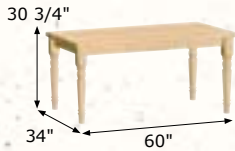

Rectangular Butcherblock Top with Drawer • 534W

This top is made from 2" thick solid Alder butcherblock and features a drawer for additional storage. It will comfortably seat six people, and can be combined with any of the styles of legs featured. Our gathering legs allow you to put your table at island height for use with counterstools. Made of solid Alder hardwood.



Shown with Heritage Legs • 557W



Saber
Legs • 580W



Bordeaux
Legs • 555W



Large Sheffield
Legs • 574W



Metropolitan
Legs • 559W



Large Metropolitan
Legs • 573W



Simplicity
Legs • 562W



Large Simplicity
Legs • 569W



Large Kingswood
Legs • 577W

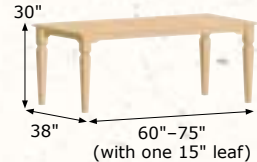

Rectangular Plank Extension Top • 538W

This top is made from 1 1/4" solid Alder planking. The table extends to a full 75" and seats eight people comfortably. This top can be combined with any of the styles of legs featured to create a beautiful dining table. Our gathering legs allow you to put your table at island height for use with counterstools. Made of solid Alder hardwood.



Shown with Metropolitan Legs • 559W



Saber
Legs • 580W



Bordeaux
Legs • 555W



Heritage
Legs • 557W



Large Sheffield
Legs • 574W



Simplicity
Legs • 562W



Large Simplicity
Legs • 569W



Large Metropolitan
Legs • 573W



Large Kingswood
Legs • 577W



Large & Standard Collection

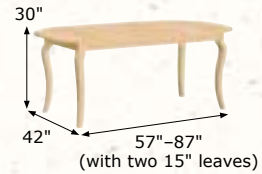

Oval Plank Extension Top • 546W

This top is made from 1 1/4" solid Alder planking and features a classic beveled edge. The table extends to 87" with two leaves, comfortably seating up to eight people. This top can be combined with any of the styles of legs featured to create a beautiful dining table. Our gathering legs allow you to put your table at island height for use with counterstools. Made of solid Alder hardwood.

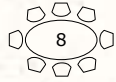

Shown with Bordeaux Legs • 555W



Saber Legs • 580W

Heritage Legs • 557W

Large Sheffield Legs • 574W

Metropolitan Legs • 559W

Large Metropolitan Legs • 573W

Simplicity Legs • 562W

Large Simplicity Legs • 569W

Large Kingswood Legs • 577W

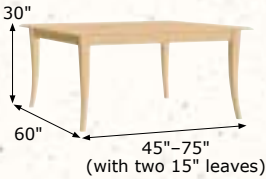

Square Plank Extension Top • 547W

This top is made from 1 1/4" solid Alder planking and features a sweeping edge. It will seat ten comfortably when extended fully. This top can be combined with any of the styles of legs featured. Our gathering legs allow you to put your table at island height for use with counterstools. Made of solid Alder hardwood.

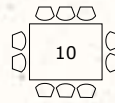
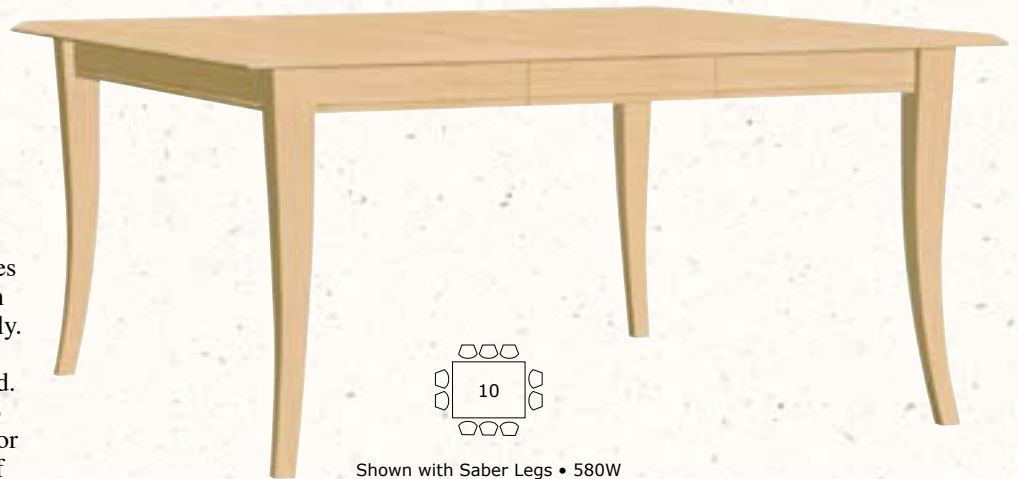

Shown with Saber Legs • 580W



Bordeaux Legs • 555W

Heritage Legs • 557W

Large Sheffield Legs • 574W

Metropolitan Legs • 559W

Large Metropolitan Legs • 573W

Simplicity Legs • 562W

Large Simplicity Legs • 569W

Large Kingswood Legs • 577W

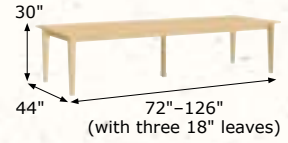

Rectangular Plank Extension Top • 551W

This top is made from 1 1/4" solid Alder planking and features a beveled edge. It will seat 12 comfortably when extended to a full 126". For added support, a hidden fifth leg can be lowered when the table is fully extended. This top can be combined with any of the styles of legs featured to create a beautiful dining table. Made of solid Alder hardwood.

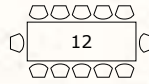

Shown with Simplicity Legs • 562W



Saber Legs • 580W



Bordeaux Legs • 555W



Heritage Legs • 557W



Large Sheffield Legs • 574W



Metropolitan Legs • 559W



Large Metropolitan Legs • 573W



Large Simplicity Legs • 569W



Large Kingswood Legs • 577W



551W Plank Table Top, 562W Simplicity Leg, 476W2 Modern Mission Chair Frames with 419W2 Black Vinyl Seats



Large & Standard Collection

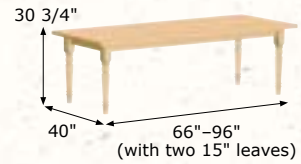

Rectangular Butcherblock Extension Top • 550W

This top is made from 2" thick solid Alder butcherblock. It will seat ten comfortably when extended to a full 96". This top can be combined with any of the styles of legs featured to create a beautiful dining table. Our gathering legs allow you to put your table at island height for use with counter stools. Made of solid Alder hardwood.

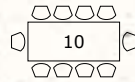

Shown with Heritage Legs • 557W



Saber Legs • 580W

Bordeaux Legs • 555W

Large Sheffield Legs • 574W

Metropolitan Legs • 559W

Large Metropolitan Legs • 573W

Simplicity Legs • 562W

Large Simplicity Legs • 569W

Large Kingswood Legs • 577W



550W Table Top with 557W Heritage Legs, 464W2 Chateau Chair Frames with 417W2 Rush Seats

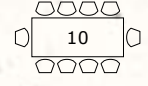
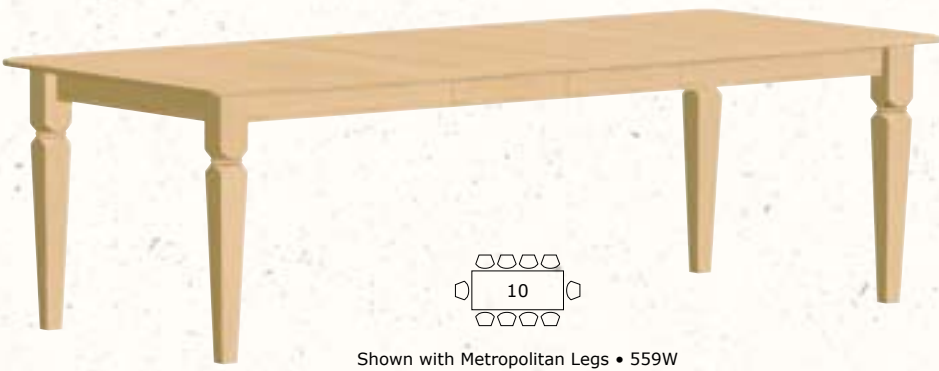
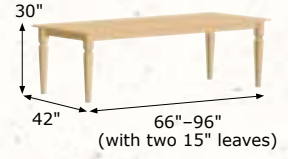

Shown with Metropolitan Legs • 559W

Rectangular Plank Extension Top • 548W

This top is made from 1 1/4" solid Alder planking. It features a beveled edge. It will seat ten comfortably when extended to a full 96". Can be combined with any of the styles of legs featured to create a beautiful dining table. Our gathering legs allow you to put your table at island height for use with counter stools. Made of solid Alder hardwood.



Saber Legs • 580W
 Bordeaux Legs • 555W
 Heritage Legs • 557W
 Large Sheffield Legs • 574W
 Large Metropolitan Legs • 573W
 Simplicity Legs • 562W
 Large Simplicity Legs • 569W
 Large Kingswood Legs • 577W

Create a Table Collection		Fits Standard Legs				Large Legs				Counter Height Legs		
Table Tops		555W	557W	559W	562W	580W	569W	573W	574W	577W	560W	568W
Plank	530W Rectangular Plank Top											
	538W Rectangular Plank Extension Top											
	546W Oval Plank Extension Top											
	547W Square Plank Extension Top											
	548W Rectangular Plank Extension Top											
	551W Rectangular Plank Extension Top											
Butcherblock	534W Rectangular Butcherblock Top with Drawer											
	550W Rectangular Butcherblock Extension Top											



548W top, 197W base (Qty. 2)
and 190W Double
Pedestal Cap & Button Kit



538W top, 193W base (Qty. 2)
and 190W Double
Pedestal Cap & Button Kit



550W top, 195W base (Qty. 2)
and 190W Double
Pedestal Cap & Button Kit



546W top, 195W base (Qty. 2)
and 190W Double
Pedestal Cap & Button Kit



551W top, 403W base (Qty. 2)
and 190W Double
Pedestal Cap & Button Kit

Double Pedestal Options
for Create a Table Tops

Pedestal Base Options

Table Tops		193W Portland Pedestal Base x2	195W Rainier Pedestal Base x2	197W Fluted Pedestal Base x2	403W Large Traditional Pedestal Base x2
Plank	538W Rectangular Plank Extension Top				
	546W Oval Plank Extension Top				
	548W Rectangular Plank Extension Top				
	551W Rectangular Plank Extension Top				
Butcherblock	550W Rectangular Butcherblock Extension Top				

Cap & Button Kit • 190W

The Cap and Button Kit is required to complete the double pedestal look. The kit contains four wood buttons, four apron caps and hardware.

